

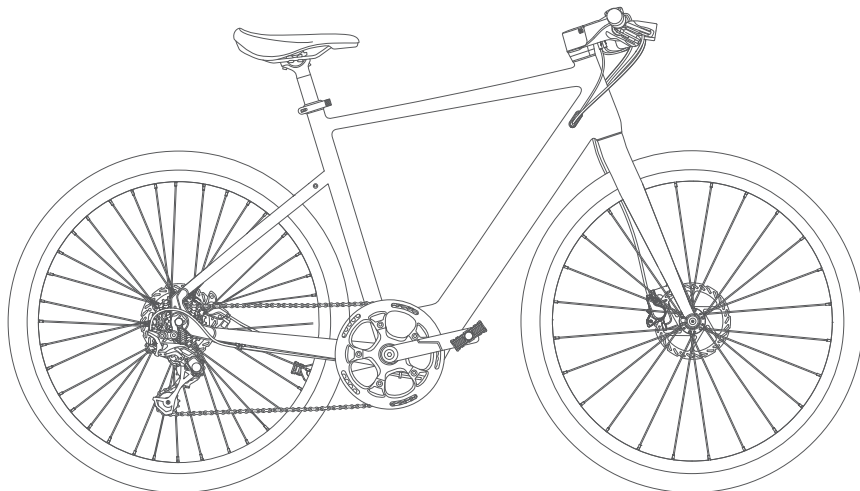

Fiido C21 Pro Electric Bike



Dear users, please read this manual carefully before operating the bike.
WARNING: DO NOT OPERATE THE BIKE BEFORE UNDERSTANDING HOW TO USE IT.

Dear user:

In this manual, we will introduce the specifications, installation, usage, precautions, and maintenance of the Fiido C21 Pro. Please ensure that you have a thorough understanding of everything outlined in this manual regarding the bike.

If you have any questions, please do not hesitate to contact the Fiido After-sales Team or our Local Service Center. We will provide a prompt reply and a feasible solution to your inquiry.

Safety precautions

1. Please follow the precautions in this instruction to effectively reduce risks. When entering public areas, please obey national and local regulations, remain vigilant while riding, and maintain a reasonable safe distance from other people and vehicles.
2. Please operate by the instruction of the user manual, the loss caused by not following the instructions shall be borne by oneself.
3. This product is not professional off-road bike, do not use this product according to off-road standards.
4. For the first time riding, please keep away from children, pedestrians, pets, vehicles, or other obstacles and potential hazards. Please be familiar with the bike before riding on public main roads.
5. Before each ride, please carefully check the parts and screws of the bike to make sure it is working well. If there's any unusual noise, please stop riding immediately, and contact after-sales team for help.
6. To avoid injuries, please read and follow all "Caution", "Danger" and "warning" instructions in this user manual. Please don't speeding, and do not ride in motorized road under any circumstances.
7. For safety consideration, user must be over 16 years old. Users under the following circumstances are strongly not recommended to use this product:
 - People affected by alcohol or drugs.
 - People who are unable to engage in strenuous physical activity due to illness.
 - People who are unable to maintain balance or whose balance is impaired by motor skills.
 - People whose weight exceeds the max load limit (max load is 120KG/265lb).
 - Pregnant woman.

8. Please ride carefully in snow, rain, wet road, ice and other bad weather. Do not ride over too high or too large obstacles, otherwise it's very likely to lose balance or grip and cause injuries.
9. Do not attempt to charge while the charger or power supply is wet, please follow the local safety regulations if you need to charge the bike in public area.
10. For effective protection and as convenient as possible for yourself, please be sure to use Fiido specific parts.
11. If you need to retrofit your bike, Please follow the local laws and regulations, after consulting with Fiido after-sales team, then proceed with caution. Serious injury and/or damage caused by unauthorized modification will result in the void of warranty.

CONTENTS

1.Product introduction

- 1.1 Bike overview
- 1.2 Packing list
- 1.3 Bike diagrams
- 1.4 Function DESC

2. Using guide

- 2.1 Installation guide
- 2.2 First time using
- 2.3 Charging instructions

3.Maintenance precautions

- 3.1 Using precautions
- 3.2 Bike maintenance & repair
- 3.3 Motor maintenance & repair
- 3.4 Battery maintenance & repair
- 3.5 Reflex reflector cautions

4. Service directory

- 4.1 Troubleshooting methods
- 4.2 Specifications
- 4.3 Warranty coverage
- 4.4 Repair record

* All pictures are for reference only.

1. Product introduction

1.1 Bike overview

1.2 Packing list

1.3 Bike diagrams

1.4 Function DESC

1.1 Bike overview

The C21 Pro is Fiido's latest city e-bike, featuring brand new technology and Fiido's iconic minimalist design style. It is the first city e-bike on the market with proximity start. Equipped with the newest Fiido modular mid-mounted meter, it can be connected with the Fiido Riding App and Fiido Mate smartwatch. The advanced torque sensor and 17.5kg(39lb) lightweight frame provide the most agile riding experience. The elegant integrated battery and 3-hour fast-charging make the C21 Pro the most helpful ridingbuddy for commuting and city riding.

The Fiido C21 Pro features 2 riding modes, 5 power-assisted gears, and a 9-speed transmission system to provide a richer riding experience and extend to more cycling scenes.

1.2 Packing list

Bike parts

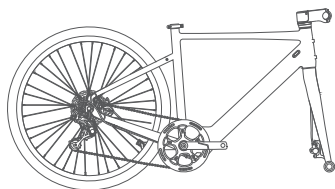

Electric Bike*1

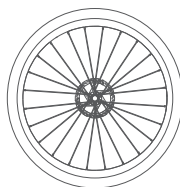

Tires*1



Handlebar*1

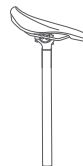

Seatpost*1

Bike accessories



Fenders*1



Pedals*1



Headlight*1



Meter*1



Taillight*1



Charger*1



User manual*1

Tools

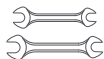

Open spanner*2



Hex wrench*8



Y-Type Allen Wrench*1



Screwdriver*1

*Please carefully check that all items are complete and intact. If there are any problems, such as missing or damaged components, please contact the official after-sales team as soon as possible.

1.3 Bike Diagrams

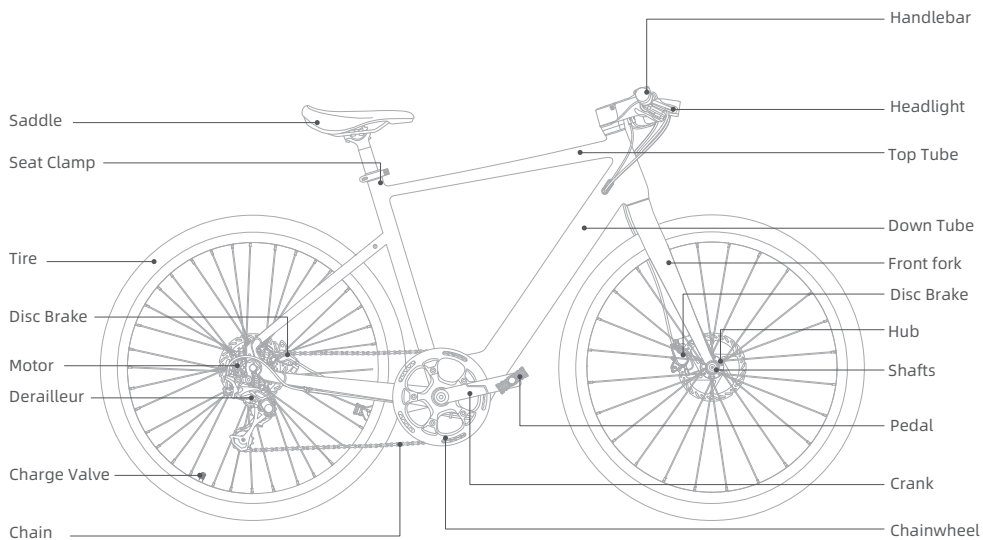

*Non-professionals are prohibited from assisting with and assembling the battery. Please contact the after-sales team for assistance.

1.4 Function DESC

Handlebar

Connect with bluetooth

(To connect the Fiido Mate cycling watch, please simultaneously press the "M" button and "Power-assisted Shift Up" buttons. The Bluetooth connection icon will blink during the connection process. Once connected, the icon will remain solid.)

Overheat Protection

(When the controller temperature is too high, this icon will be displayed and the output power will be relatively reduced, to reduce high load operation and restore power)

Battery Status

(Display remaining power)

Switch between KMH/MPH

Speed

(Display the current speed)

Power Assisted Gear Display

(Display the current power assisted gear)

Shift Up

(Press outward achieve transmission upshift)

Shift Down

(Press outward achieve transmission downshift)

Power-assisted Shift Up

① Click to achieve the power-assisted upshift.
② Press it for 3 seconds to switch the display between KMH and MPH.

Power-assisted Shift Down

(Click to achieve the power-assisted downshift)

ECO Mode

(When the Battery power is less than 10%, this icon will be displayed, and the power output will be weakened. Please charge in time.)

Headlight

(Press and hold: Turn on/off lights.)

Pedal Assist Level

(Press the button to switch the pedal assist level.)

Horn

(In case of overtaking, road section affecting safety visibility or emergency, slow down and ring the bell for signal.)

Functional Button

(Click to switch the display of the data.)

Power-on Button

(Long press for more than 3 sec: turn on/off the power assisted mode.)

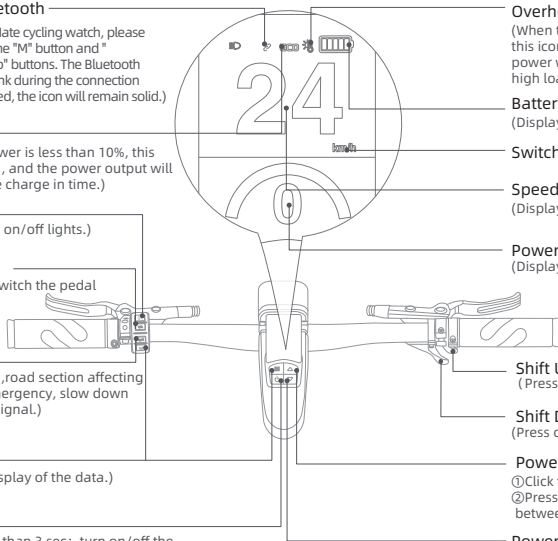

Battery

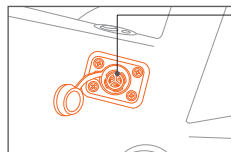

Charging Port

(Charging Port Please connect the Fiido charger to charge the battery.)

ATTENTION: ① Equipped with fool-proofing, it required to be inserted only when it is aligned with the bayonet. Turn the charging cable counterclockwise to pull out the blue circle successfully.
② Insert the Fiido charger ONLY.

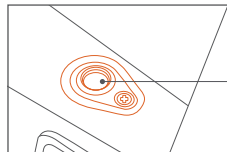

Power Button

2.Using Guide

2.1 Installation guide

2.2 First time using

2.3 Charging instructions

2.1 Installation guide

The basic installation of the bike has been completed before leaving the factory. When you receive the bike, you only need to install the handlebar, meter, headlight, front wheel, pedals, and lock the seat saddle.

Install the handlebar

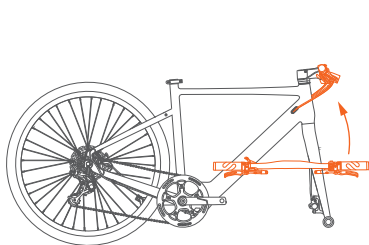

① Raise the handlebar to the right position.

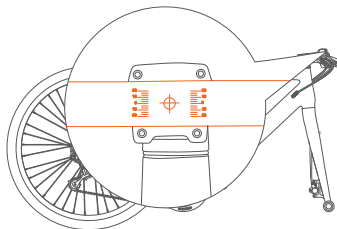

② Align the handlebar scale to the front of the bike.

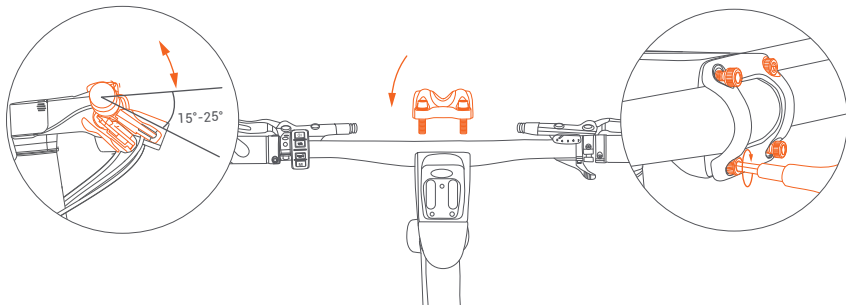

③ Cover the riser cover, use a three-fork wrench to lock the screws, then rotate the handlebar and adjust the brake angle to 15~25° downward parallel to the ground, and then tighten the screw.

(ATTENTION: The riser cover screws should be tightened with force to avoid safety hazards.)

Install the front wheel

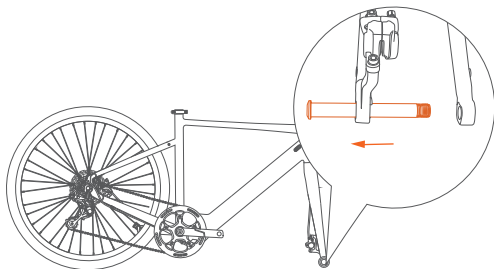

- ① Remove the front brake spacer and unscrew the shaft on the front fork.

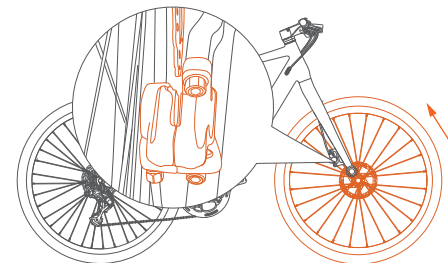

- ② Lift the front part of the bike, align the front wheel and insert the front fork sleeve ring.

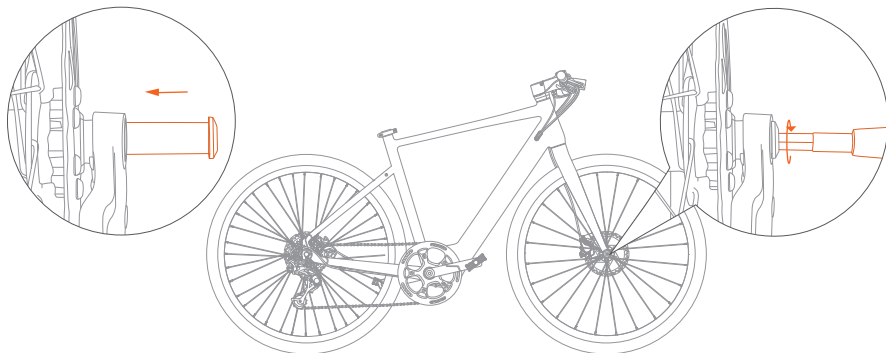

- ③ Put the shaft through the front wheel and tighten it clockwise with a three-prong wrench to complete the installation for front wheel.

Install the meter

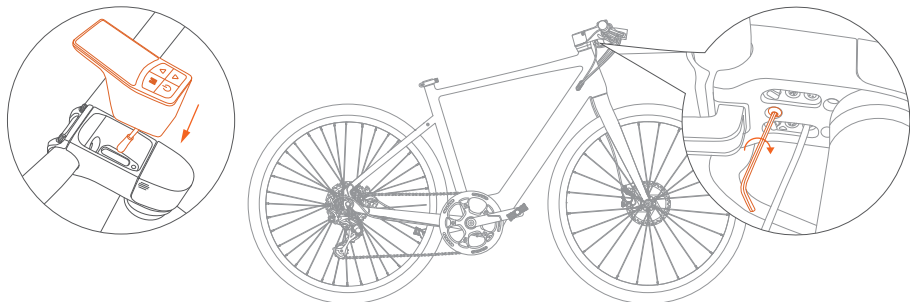

Place the meter in the groove of the handlebar. Use the hexagonal tool to tighten the screw to fastening the meter on the handlebar.

Install the front light

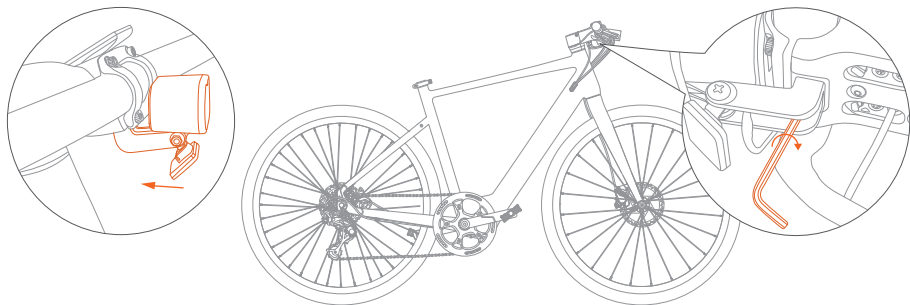

Align the headlight screw hole with the bottom hole of the handlebar, insert the screw and tighten it.

Insert the wire

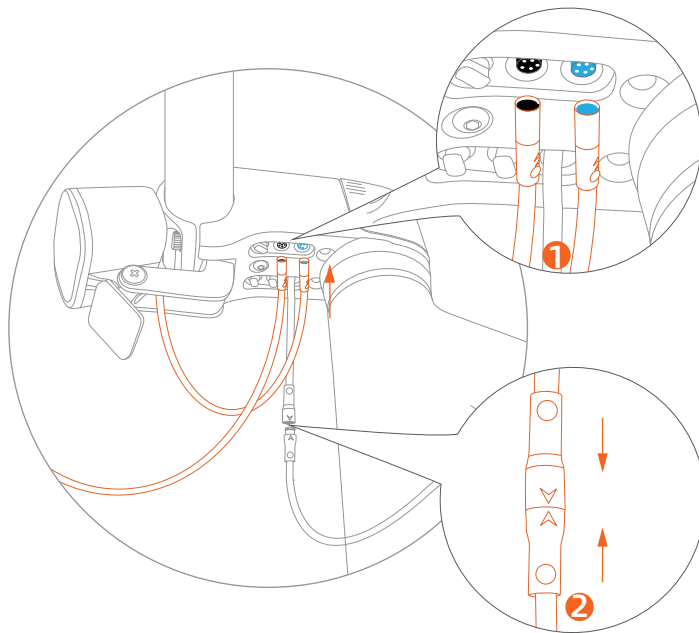

- ① Insert the light wire and horn wire according to the wire color, like picture 1, align the interface and make sure the direction of arrows is the same direction.
- ② Insert the meter wire and make sure the direction of arrows is on opposite.

(ATTENTION: The installation interface is equipped with fool-proofing, if the direction of the interface is wrong, the installation will not be completed. Please make sure to insert the wire on the correct direction.)

Install the seatpost

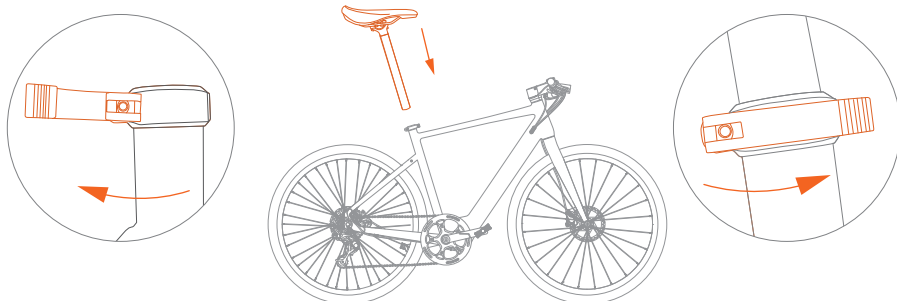

① Open the seat clamp, insert the seatpost.

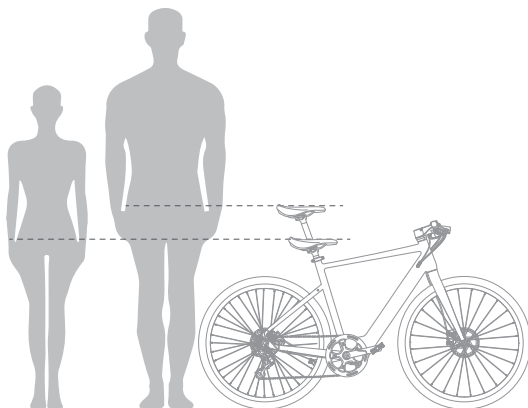

② Adjust the seatpost to suitable height, the recommended height is when the saddle is level with the user's pelvis when standing naturally. The height of the adjustment can NOT exceed the safety line.

Install pedals

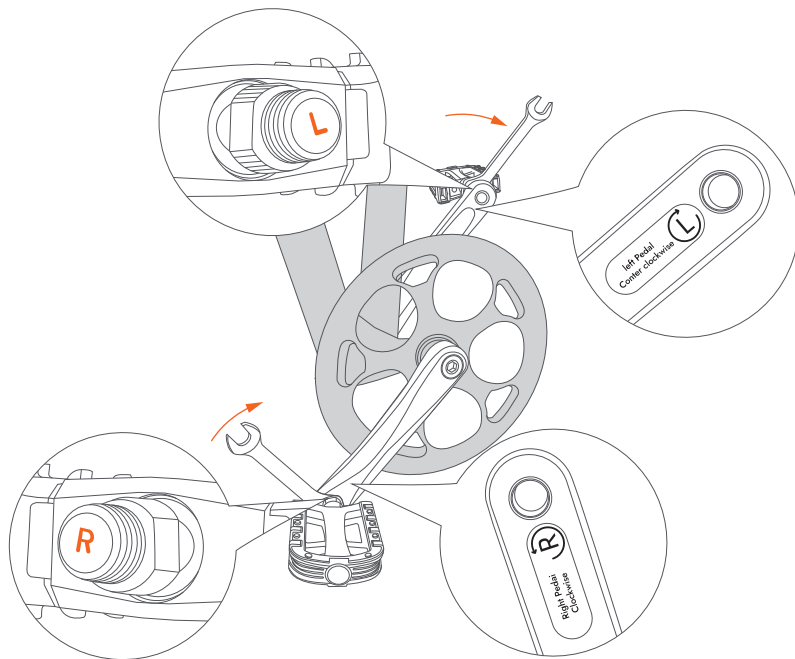

Use the open spanner of the tools bag, screw the pedal shaft into the threaded hole and tighten it in the direction of the arrow.

Caution: While installing the pedal, pay attention to the left / right pedal corresponding to the left / right crank, the pedal screw and the inside of the crank are respectively marked L(left) / R(right). Please install the pedal correctly to prevent it from sliding out of the crank.

2.2 First time using

Before riding, please follow the installation guide to install components properly, check whether the firmware is loose, ensure sufficient power, and take appropriate protection for riding.

Step 1: Adjust the seat

Please adjust the seat to the appropriate riding height according to your height.

(The recommended height is when the saddle is level with the user's pelvis when standing naturally.

The height of the adjustment can NOT exceed the safety line)

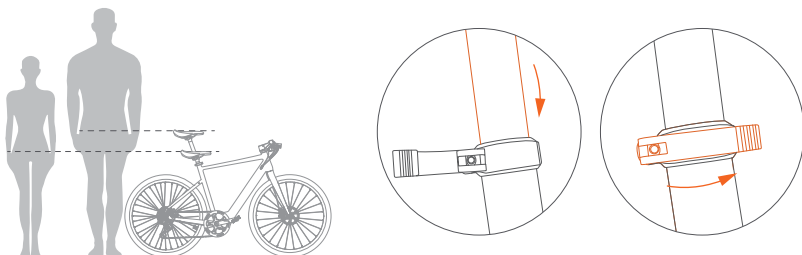

Step 2: Turn on the power

① Click the power button to turn on the battery power, then long press the “⏻” button of the display to turn on the bike power.

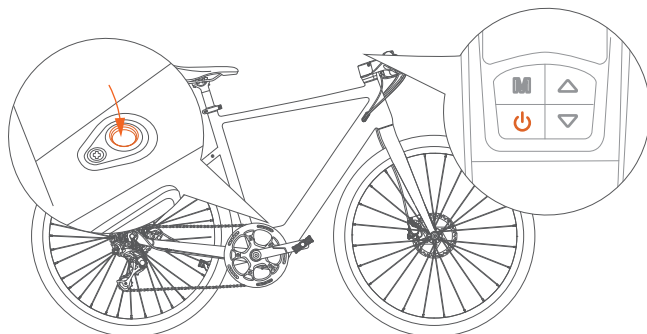

Step 3: Mode switching

Switch and choose the riding mode according to the cycling road conditions and personal needs.

- ① Switch the power-assisted gear: Equipped with 3/5 power-assisted gears, please click the "⚙️" button on the left handlebar to switch the gear.
- ② Switch the transmission gear: Equipped with 9 transmission gears, please push outward the shifter on the right handlebar to switch the gear.
- ③ Switch the display on meter: Press the "Λ" button and hold to switch the display between KMH and MPH. Click the M button to display the current range, top speed, average speed and total range etc.

Attention: When the bike is on PAS0 state, by then the gear display won't be lighted and the power assisted mode will be turn on. The bike will be on pedalling mode.

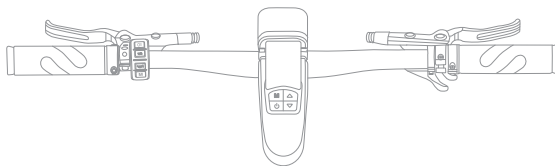

Step 4: Start riding

Please take corresponding protection before starting riding.

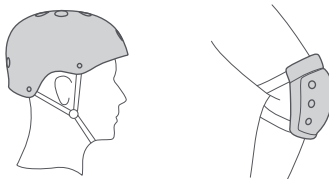

Step 5: Braking introduction

The left side is front brake, the right side is rear brake. (The UK version: Left side for rear brake right side for front brake.)

While riding, it's recommended to use the rear brake first, then the front brake to slow down the speed to stop, in order to avoid falling accident caused by balance problems from urgent front wheel brake.

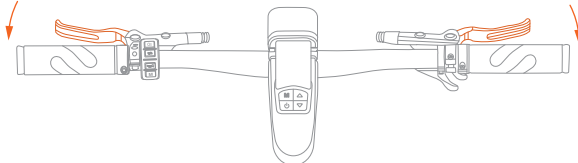

2.3 Charging instructions

The battery comes with a small amount of electricity, before the first time use, please make sure to charge it to full power before riding.

Charging

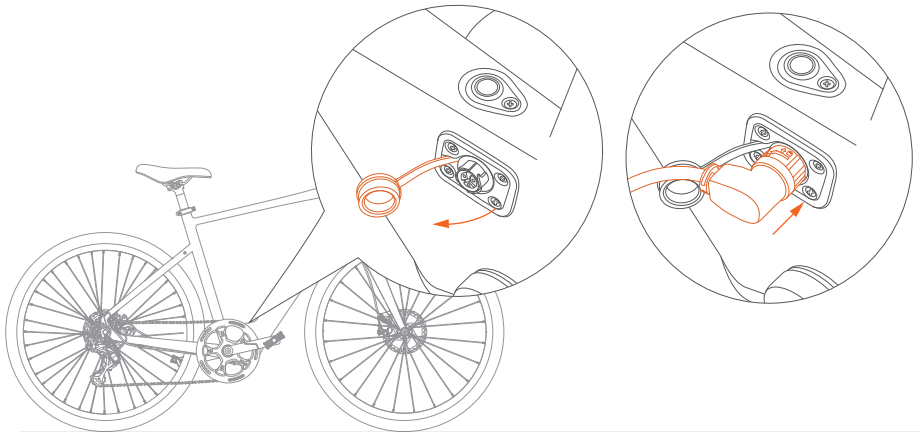

1. Equipped with fool proofing. The adapter cable head must be inserted from the left while connecting the adapter
Charging connection: Connect the charging interface of the charger to the charging port, then connect the power plug of the charger to the power socket.
2. Fully charged : When the indicator light of the charger is red, means it's normal charging. When the light is green, means it's fully charged.
3. Charging hour: Charging hour is around 3 hours, The duration depends on the situation.
4. Disconnect charging: When the indicator light turns green, means it's fully charged. Unplug the power plug first, then remove the charging interface from the battery. Close the battery dust cover. The dust plug must be closed in time after charging.

(Align power interface, insert the battery power wire to connect the battery power supply. Turn the blue circle counterclockwise to pull out)

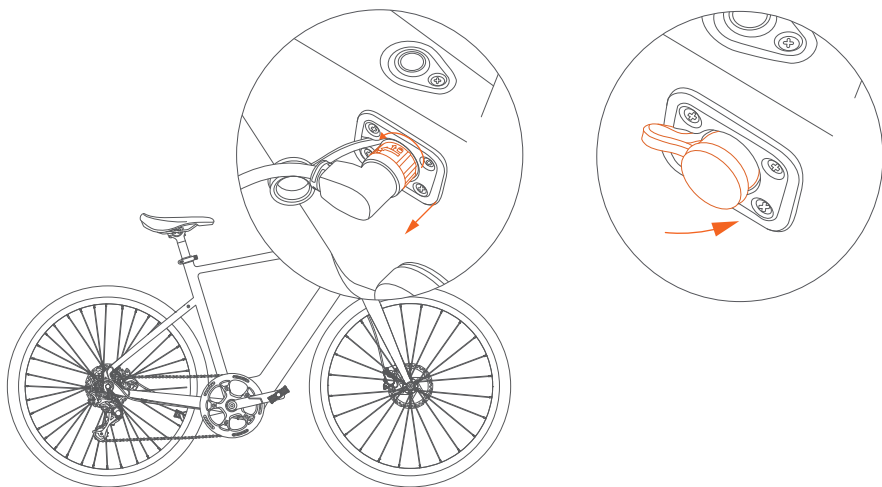

- Caution: ① Charger has high voltage device, DO NOT repair without permission. In order to avoid danger, battery and charger should be placed away from children. There should be no inflammable and explosive objects around the batteries (such as car seat cushions, sofas, etc.)
- ② Keep the battery in a ventilated and dry place, and make sure NOT to charge in open-air place, to avoid electrical short circuit fire and other accidents caused by rain and other factors, and to prevent liquid and metal particles into the electrical parts.
- ③ Make sure to charge for more than two hours every month under chronically store condition. Do not store the battery at a loss of power. Once the battery voltage reaches the discharge state, will cause unrecoverable damage.
- Danger: Charging can be allowed on public charging equipment, but the matching between the battery and the charging equipment should be fully considered.
- Warning: If there's any odor or high temperature during charging, please stop charging immediately and contact after-sales team for assist.

3.Maintenance precautions

3.1 Using precautions

3.2 Bike maintenance & repair

3.3 Motor maintenance & repair

3.4 Battery maintenance & repair

3.5 Reflex reflector cautions

3.1 Using precautions

(I) Users should pay attention to the safety of bicycle use

1. No parking in building foyers, evacuation stairs, walkways and safety exits.
2. No charging in residential buildings. Charging should be far away from combustible, and no longer than 9 hours.
3. Prevent water from entering electrical parts. When cleaning the bike, avoid water impact on charging port, wiring harness connectors, fuse and other electrical parts.
4. When adjusting the height of the saddle, the safety line mark of the seatpost should not be exposed.
5. Users and dealers must not wiring and modifying structure and performance without permission. Such as: change the battery configuration, the circuit, increase the lamp power, increase the sound and other modification.
6. Please do not change the instrument background parameters settings at will, otherwise normal riding cannot be guaranteed.
7. Please do not unplug any live wire interface in the powered-on state to avoid damage to accessories (such as instrument panel, controller, etc.)
8. Do not touch the live part of the bike with wet hands or metal conductors. Such as: charging port, charger plug etc.
9. When replacing circuit breakers or fuses, use circuit breakers or fuses of the specified models and specifications. Do not short-fuse wires. The circuit breaker or fuse card slot should be in good contact, or may cause the accidents.
10. Please do not disassemble electrical parts without authorization to prevent liquid and metal particles from infiltrating into electrical parts.
11. Do not ride on bad weathers, or place the bike in a long-term exposure to the sun/rain to avoid parts aging.
12. If scrub the bike is needed, please wipe the body with a neutral lotion mixed with tap water. Do not remove and wash internal parts to avoid short circuit.

Caution: Non-professionals are strictly prohibited to repair. In case of failure, please contact the after-sales team or authorized professional maintenance station for maintenance.

(II) Riding safety: please follow the national and local traffic laws and regulations, pay attention to riding safety.

1. User must be over 16 years old. Do not lend to people who can not operate the bike to avoid the harm.
2. Please ride in Non-Motor Vehicle Lane, with the max speed no more than 25km/h and following the local regulations
3. Please carry persons or goods in accordance with local laws and regulations while riding.
4. Please be sure to wear a suitable safety helmet and fasten the helmet wind strap while riding.
5. The braking distance will be extended in rainy and snowy days, please pay attention to slow down, and try to avoid to ride on bad weathers. Inner short circuit and electrical parts damage may be caused if the water level reaches the center of the hub of the rear wheel motor, please noticed.
6. Please follow the local traffic rules carefully. No riding after drinking, and make sure to always ride with both hands.
7. Bright colors, relaxed, and comfortable suit are suggested for riding, and wear low-heeled shoes for riding is necessary.

(III) Examination before riding: please repair in time or go to the local maintenance point for repair, if there's any abnormality.

1. Please confirm the normal power use when using the kickstand and the rear wheel is off the ground.
2. Turn on the power, check whether the indicator light is normal, and the power supply is sufficient.
3. Check whether the bell and front/rear light are in good condition.
4. Confirm whether the handlebar and seatpost are adjusted to the appropriate position, that fastening screws and quick release are fastened. Be attention that the safety line should not be exposed.
5. Check the front/rear brake handle, brake adjustment should make the brake reliable and flexible reset.
6. Check whether the tire pressure is normal, no cracking, abnormal wear, nails, stones, glass and other sharp objects.
7. Check whether the front/rear wheel screws are locked, the side, rear and pedal reflectors are in good condition.
8. Check whether the front /rear lighting is normal and ensure that lights can be good used while riding.
9. Check the fastening state of each axle to ensure the front/rear axles are in a reliable state.
10. Before using the product, please pay attention to checking whether the torque of each component screw is within the specified range. Only when it meets the standard range can it be used normally: tighten the handlebar cap to 6-8N.M, seat post screws to 10-15N.M, thumb throttle to 6-8N.M, brake lever to 6-8N.M, chainwheel to 30-50N.M, front axle to 15-20N.M, and rear motor wheel to 30-45N.M.

Caution: abnormal tire pressure, tire cracking damage and abnormal wear are the main causes of steering failure and tire burst.

(IV) Attentions on the road

1. For your safety and the safety of others, please obey the local traffic rules consciously.
2. Before riding, be sure to wear a safety helmet, take safety precautions and maintain a natural posture.
3. At the beginning of riding, please slowly accelerated, to avoid the energy waste or accidents.
4. For a longer service life of the battery and motor, when start riding or climbing, please try to use power assisted mode.
5. To ensure safety, economic speed should be used as far as possible, and reduce frequent braking, frequent start as far as possible, to save electricity.
6. avoid the phenomenon of tightening the speed control handle after braking
7. Riding on muddy areas or uneven roads should use pendal mode as far as possible.
8. Braking distance should be appropriately increased on bad weathers, please be concentrated and careful while riding.
9. Equipped with overcurrent protection. The circuit may be overcurrent under the condition of higher uphill Angle and higher headwind speed. It's better to use pendal mode, otherwise, power consumption may be too fast to affect the range, motor and electrical appliances burn. The body and electrical parts should not be electriferous, the insulation resistance value shall not be less than 2M ω .
10. Controllor has undervoltage protection, the power will be cut off automatically if the voltage is lower than the undervoltage value, to maintain the service life of the battery.

(V) Attentions of pushing and parking

- 1.The power should be off when pushing the bike, to avoid the accidents.
- 2.Parking should be on the level ground, and maintain the bike as power off status.
- 3.For your safety, please maintain and clean your bike regularly to keep it in the best condition.

3.2 Bike maintenance & repair

1. The bicycle has been checked and adjusted before out of factory, any problems please contact Fiido After Sales Team for support.
2. Normally the spokes of the wheel should be adjusted once after half a month of riding to ensure the best use.
3. Make sure to check the storage capacity of the tire regularly to keep it in normal use.
4. Make sure to check the main parts like handlebar, stem, saddle, seatpost, front/rear and centre axle, flywheel and chain, wheels, to keep it in normal use, nut and screw loose should be tightened in time if it loose.
5. In use, it's recommended to add 3# calcium base lubricating oil (butter) every six months to the parts that need lubrication. (such as front/middle/rear axle bearing, front fork bowl group, foot pedal bearing, etc.) Add 30# oil to the chain, brake cable, support and other parts every two months.
6. If the vulnerable parts are damaged, such as: brake line, brake skin, brake pad, bulb, fuse, etc. Please find the local maintenance center to replace, but be sure to replace with the same model specifications of the parts.

Cautions: Handlebar core screw fastening torque, combined handlebar joint screw fastening torque, saddle clamp screw fastening torque, front wheel fastening torque recommended torque is not less than 18NM;The recommended torque for fastening the central shaft lock mother and rear wheel is not less than 30NM. Handlebar and saddle tube safety line should not be exposed outside the body.

3.3 Motor maintenance & repair

1. Equipped with rare earth permanent magnet DC brushless, external rotor hub motor, without any deceleration mechanism and carbon brush, which is basically maintenance-free.
2. Do not open the motor base and end cover after sealing.
3. Keep the motor clean, no foreign matter, corrosive liquid, gas into the motor, do not knock and bake the motor shell, so as not to damage the motor.

Caution: If the issue still exists, please contact Fiido customer care team.

3.4 Battery maintenance & repair

1. Lithium battery has the characteristics of large capacity, long life, maintenance-free, light weight, pollution-free etc. Its service life is closely related to using mode. Do not store chronically, please form the habit of frequent charging.
2. It is recommended to charge for 7 - 9 hours each time, and the longest time is not more than 1 day. Lithium battery has no memory effect, can be used with the charge.
3. Make sure to charge for more than two hours every month under chronically store condition. Do not store the battery at a loss of power. Once the battery voltage reaches the discharge state, will cause unrecoverable damage.

Danger: Do not dismantle old battery without authorization, it should be collected according to regulations.
Warning: Do not near the fire or high temperature source, or throw it into the fire, or expose it to the sun.

3.5 Reflex reflector cautions

1. Reflex reflector device must not be missing, if it's missing, please immediately contact after-sales team for replacement, and the installation position should be consistent with the original bike.
2. Fiido reflex reflector has been fixed on the vehicle, please do not change the position, modify, disassemble, etc.
3. Make sure to check the normal function of reflex reflector before each use, and keep the surface clean.
4. The reflector device must not be covered by luggage, children's chairs, clothing and other objects, otherwise it may cause safety hazard.

4.Service directory

4.1 Troubleshooting methods

4.2 Specifications

4.3 Warranty coverage

4.4 Repair record

4.1 Troubleshooting methods

Fault code description

Fault code	Fault phenomenon
E1	Communication issues
E2	Throttle issues
E3	Brake lever issues
E4	Motor hall issues
E5	Motor issues
E6	Controller issues
ECO	ECO mode
	Overheating protection

General fault

Fault phenomenon	Fault cause	Rule out way
Through-supply motor failure	Poor contact of regulating handlebar Poor contact of brake cut-off switch Motor damage Controller damage Loosened connector	Change regularing handlebar Change brake cut-off switch Change motor Change controller or get repair Check the connector
Lack of range	Tire pressure deficiency Undercharged or faulted charger Aging battery or damaged battery More uphill, gale, frequent braking, overload, etc	Blow up the tire Fully charged, check charger Change battery Using pendal mode
Difficulty in charging	Loosened plug Disconnected battery cable Damaged charger	Tighten socket and connector Welded connector Change charger

4.2 Specifications

Property index	Item	Fiido C21 Pro
Product size	Before folding: Length*Width*Height (mm)	1800*670*1010
	Net weight	17.5kg(39lb)
	Maximum load	120kg(265lb)
Product weight	Applicable age	16+
Riding requirement	Serial numbe Location	On the head tube
	Maximum speed	15.5MPH (25km/h)
Main spec	Center distance between wheels (mm)	1090
	Applicable road	Urban asphalt pavement/flat pavement/Off-road
	Operating temperature	- 10° ~50°
	Transmission	L-TWOO 9S
	Power assisted system	3/5gears
Battery	Rated voltage (V)	36
	Battery type	Lithium battery
	Rated capacity (Wh)	208.8
	Battery management system	Overheat/short circuit/overcurrent and overcharge protection
Motor	Torque (N·m)	22
	Rated speed (r/min)	245
	Moter type	Brushless geared motor
Controller	Undervoltage protection (V)	31±1
	Overcurrent protection (A)	16±1
Charger	Input voltage (V)	100-240
	Output voltage (V)	42
	Output current (A)	2
	Charging hours (h)	3
Others	Front light	LED
	Tail light	LED
	Riding mode	Electric mode+Power assisted mode+Pedal mode

Caution:

* The above data allow for 5% manufacturing tolerances.

* After receiving the bike, there may be some differences between individual accessories and display drawings, which are different due to the different batches, and do not affect the use.

4.3 Warranty coverage

(I) Warranty principle

1. Users should operate correctly according to this user manual. In case of performance failure caused by production quality, according to relevant laws and national provisions of the three guarantees, the company shall uniformly perform the obligations of the three guarantees.
2. The faults beyond the warranty scope and the main parts after the warranty period shall be repaired by the company but shall be charged at the discretion.
3. Regards the battery replacement after the warranty period, will be charged with the factory price, but the old battery must be returned to the manufacturer, to ensure safety and avoid environmental pollution.

(II) Warranty scope and period

Item	Parts	Guarantee time	Service
Basic parts	Frame	36 months	Natural deformation, open welding, desoldering fracture phenomenon, quality problems caused by poor manufacturing can be replaced. Self-modification, collision damage, etc. are not warranted.
	Fork, Handlebar, Stem, Seatpost	12 months	
	Kickstand, Tires, Saddles, Fenders, Safety hook, Seat clamp, Stem clamp, Frame clamp, Pedals, Brakes, Brake discs, Brake levers	3 months	Tire puncture by sharp objects, collision damage of spare parts, etc. are not warranted.
	Crank chain disc, Front arm set, Hub, Wheel hub, Spokes, Shift finger dial, Derailleur, Flywheel, Chian, Bottom bracket, Shock absorber	12 months	Man-made damage, self-modification, collision damage of parts and accessories are not warranted.
Electric parts	Controller	12 months	Short circuit, burnout, performance failure due to poor manufacturing can be replaced. Water, disconnection, and man-made damage are not warranted.
	Charger, Main wiring harness	12 months	
	Display instrument, Speed control knob, Booster, Controller cover plate	6 months	
	Headlights, Taillights, Power-off brake levers, Switches	3 months	
Motor parts	Motor, Hall, Bearing, Clutch	12 months	Phase loss, Hall element burnout, demagnetization, abnormal bearing noise can be replaced. Breakage, water ingress are not warranted
Motor parts	Lithium battery	12 months	Due to prolonged lack of charging, the battery was damaged. Replace the battery due to faults such as broken grids, no power storage, and less than 70% capacity. No warranty for water ingress or man-made damage

(III) The scope and content exceed warranty

1. Failure caused by user's failure to use, maintain and adjust according to the User Manual".
2. Failure caused by private modification.
3. Failure caused by improper use or storage by users or accidents.
4. No warranty card, or card and bike do not match.
5. Vulnerable parts and consumables, including plastic parts, spokes, rim, brake line, scratching surface etc.
6. The expenses for self-repair without the consent of the specially contracted maintenance unit.
7. After accessories leaving the factory, shell scratches or shell damage will not enjoy warranty.
8. Lead scratches or breaks.

Warranty notification

1. Accessories will be guaranteed in strict accordance with the warranty period.
2. The warranty period shall be calculated from the date of delivery.
3. No warranty will be provided if the charger, battery and motor are disassembled without permission.
4. For other parts of the bike, the quality issues will be provided three months warranty , others will not be warranty.
5. When other parts of the bike has issues, maintenance must be carried out in a professional maintenance centre, not private disassembly. Controllers, batteries, chargers must be ensured that all labeling integrity.
6. maintenance must comes with the warranty card, invoice, certificate of quality and other relevant documents.
7. The battery warranty method is 1:1. In case of battery problems, the battery should be returned to the manufacturer to determine whether the battery is covered by warranty according to battery testing standards.

4.4 Repair record

Warranty card

User	Company			
	Name		Phone	
Address				
Purchase date			Color	
Model			Order No	
Frame No			Motor No	

Repair record

Date	Maintenance	Remarks

If you have any questions or suggestions about this user manual,
please contact us via following mailaddress
Contact us: support@fiido.com



Scan for video instruction



Fiido APP



EPAC according to EN 15194



6971957790556