

## Electric Help For Bicycles



**PVY**

# Precautions for use

## Comply with traffic regulations and safety tips

- People under the age of 16 are forbidden to drive electric bicycles on the road;
- The maximum speed of an e-bike shall not exceed 15km/h in the non-motorized vehicle lane. On roads with no non-motorized lanes, you should drive on the right side of the roadway;
- Do not lend the electric bicycle to someone who cannot operate it, in case of injury;
- Electric bikes should carry people or goods according to laws and regulations;
- It is recommended to wear a helmet and pay attention to driving safety;Do not ride with one hand or both hands off the handle;
- When riding in rainy and snowy weather, the braking distance will be extended. Slow down and walk slowly. Avoid traveling in bad weather such as heavy rain.

## Safety tips for electric vehicle use

- Do not park in building foyers,evacuation staircases,walkways and exits;
- Electric bicycles should not be charged and parked in residential buildings,charging should be away from combustible materials,charging time should not be too long.
- Proper use and maintenance of batteries,old batteries shall not be dismantled without authorization,should be organized by the relevant professional departments to recover;
- Understand the safe use of the charger and warning language;When replacing the charger; it should match the model of the battery;
- Do not flush with water to avoid potential accidents caused by wetting of internal electronic parts and wiring.
- When adjusting handlebars or saddles,care should be taken not to expose the safety line marks of the risers and saddles.

## Preparation before the ride

- Power supply circuit,lighting is good.
- Whether the front and rear brakes can work normally.
- Whether the handlebars and front and rear wheels are tight
- Whether the tire pressure is normal.
- Check the reflectors for contamination before riding.

## Vehicle coding position diagram



## Electrical schematic diagram

### Specification

Size(length x width x height)	1550 x 530 x 1100 mm
Folding	910 x 400 x 690 mm
weight	22.5 kg
Maximum design speed	25 km/h
Assisting range	80 km
Electric range	30-50 km
Loading weight	≤150 kg

Under the condition of full power,the endurance is 75kg,the temperature is about 25°C,the environment of flat road is still without wind,and the driving condition is measured at 15km/h uniform speed under the energy-saving mode.The actual endurance will be different due to factors such as load, temperature,wind speed,road surface and operating habits.

### Motor Spec

#### Battery Spec

Battery type	Lithium ion battery
Capacity	10Ah
Voltage	36V

Motor type	Brush-less dc motor
Power before unlocking	250W
Rated power	500W
Voltage	36V

#### Controller Spec

Under voltage protection	38V
Over current protection	15±2A

# Operation and using

## Folding step

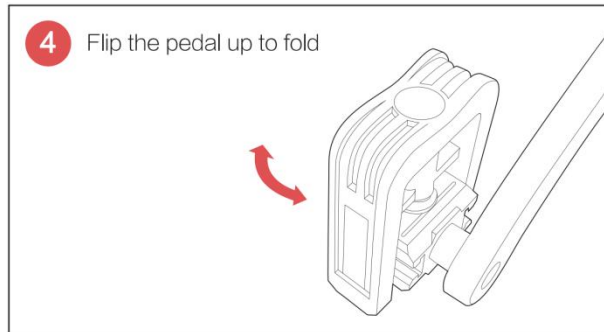
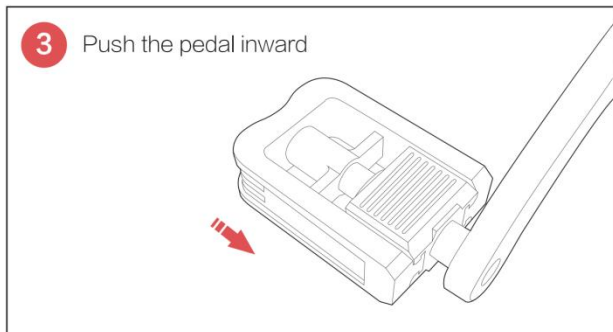
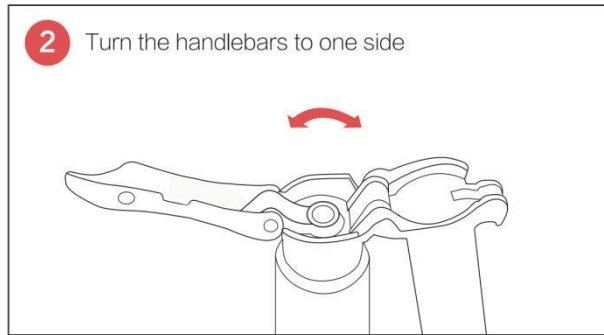
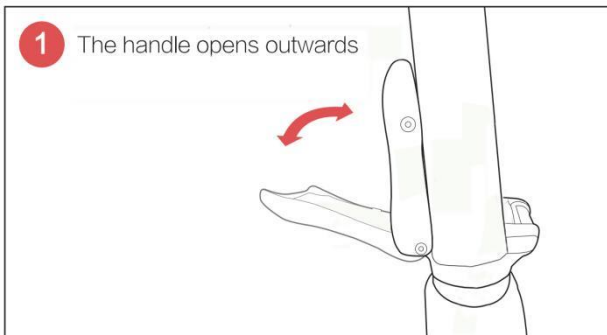

# Operation and using

## Folding step

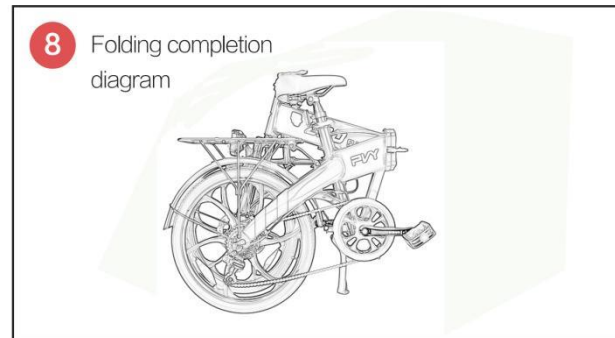
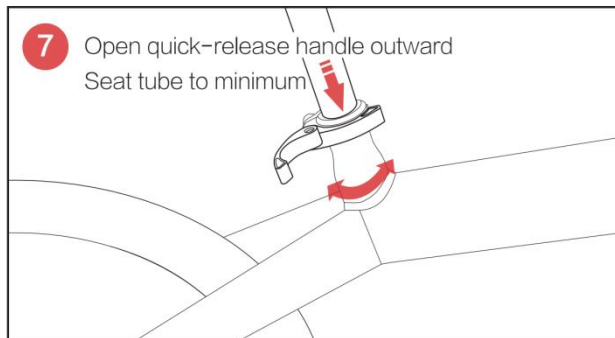
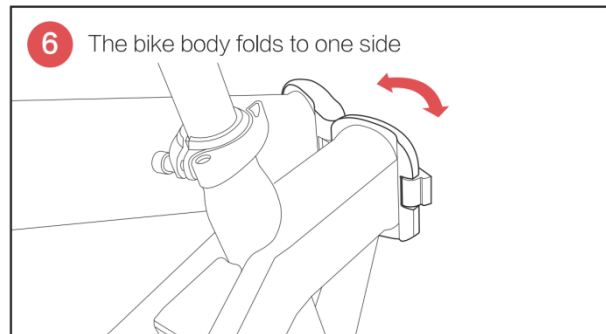
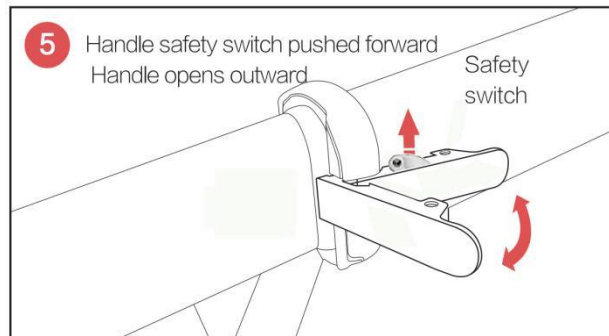

# Transmission use

## Transmission diagram

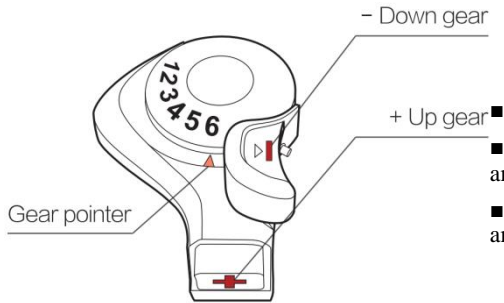

Gear	Intensity	Speed
1-2	Relax	Slow
3-4	Moderate	Moderate
5-6	Hard	Fast

- To speed up, start in a lower gear and switch to a higher gear as you speed up.
- As you go uphill, your speed drops, and you lower your gear to maintain a certain amount of pedal power.
- When the wind is in the wind, you speed up and shift gears to maintain a certain amount of pedal power.

The above is the cycling suggestion. You can use the gear properly according to your personal habits.

## When using the driveline, pay attention to the following details

- When using a gear shift system, try not to skip gears as they can easily damage the transmission. It is also possible to change more than two gears, should be a level of adjustment, can better protect the transmission system.
- When the bicycle stops running, or when going downhill, do not reverse the rotation system, which is not only bad for the transmission system, but also can cause accidents.
- If the transmission fails, or the gear is not accurate, it will affect the performance of the transmission. At this time, you should go to a professional bicycle shop for maintenance in time to prevent the failure from worsening.

## Dashboard and cycling mode

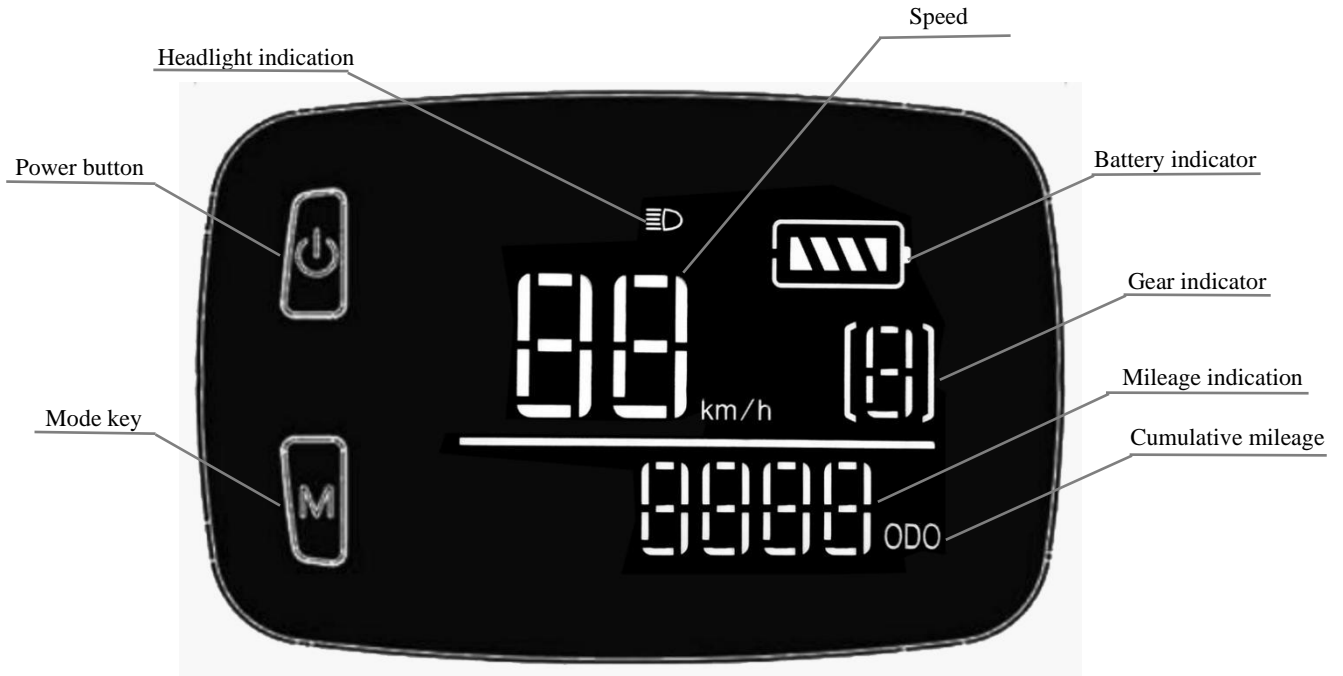

## Battery instructions

### The battery

- The power supply pin of the charger is inserted into the charging port of the battery, and the power supply pin of the other end is connected to the power supply
- When charging, the status light of the charger is red
- When the battery is fully charged, the charger is in green and charged
- If the battery is charged in the e-bike, turn off the meter

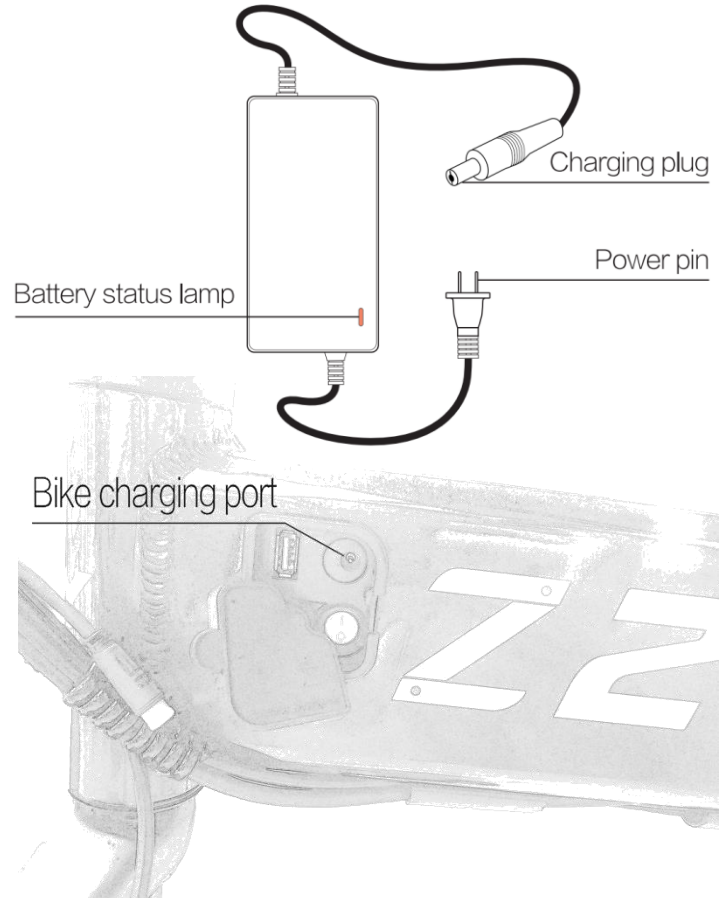
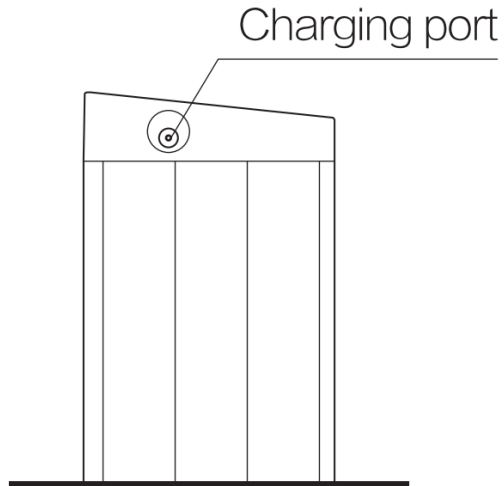



## Battery instructions

### Battery removal and installation

- Insert the key and turn it to the end in the direction indicated by the arrow. Release the battery lock and pull back to take out the battery.
- Push the battery into the bottom slowly along the predetermined position, and the battery installation will be completed when the battery latch springs back and locks.

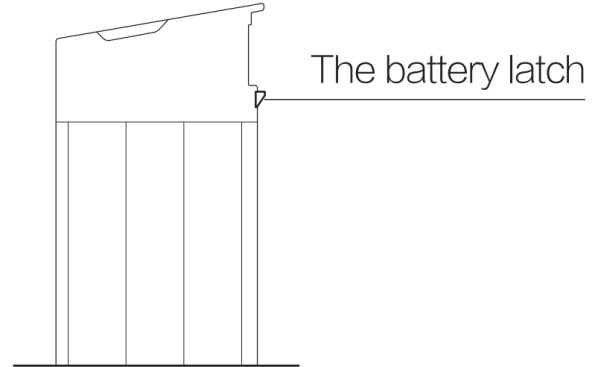

Battery lock

Note:when the battery is unlocked,the key cannot be dialed out.If you keep the unlocked state and pull back,you can take out the battery.

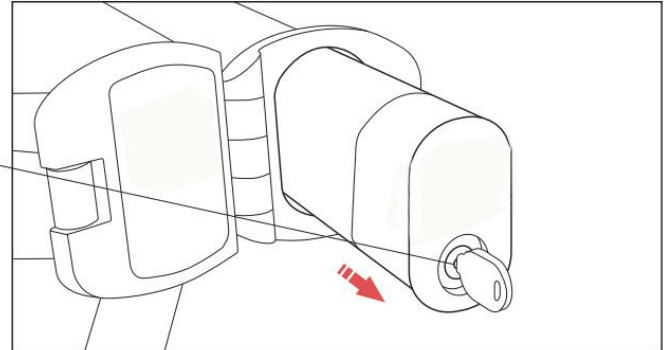

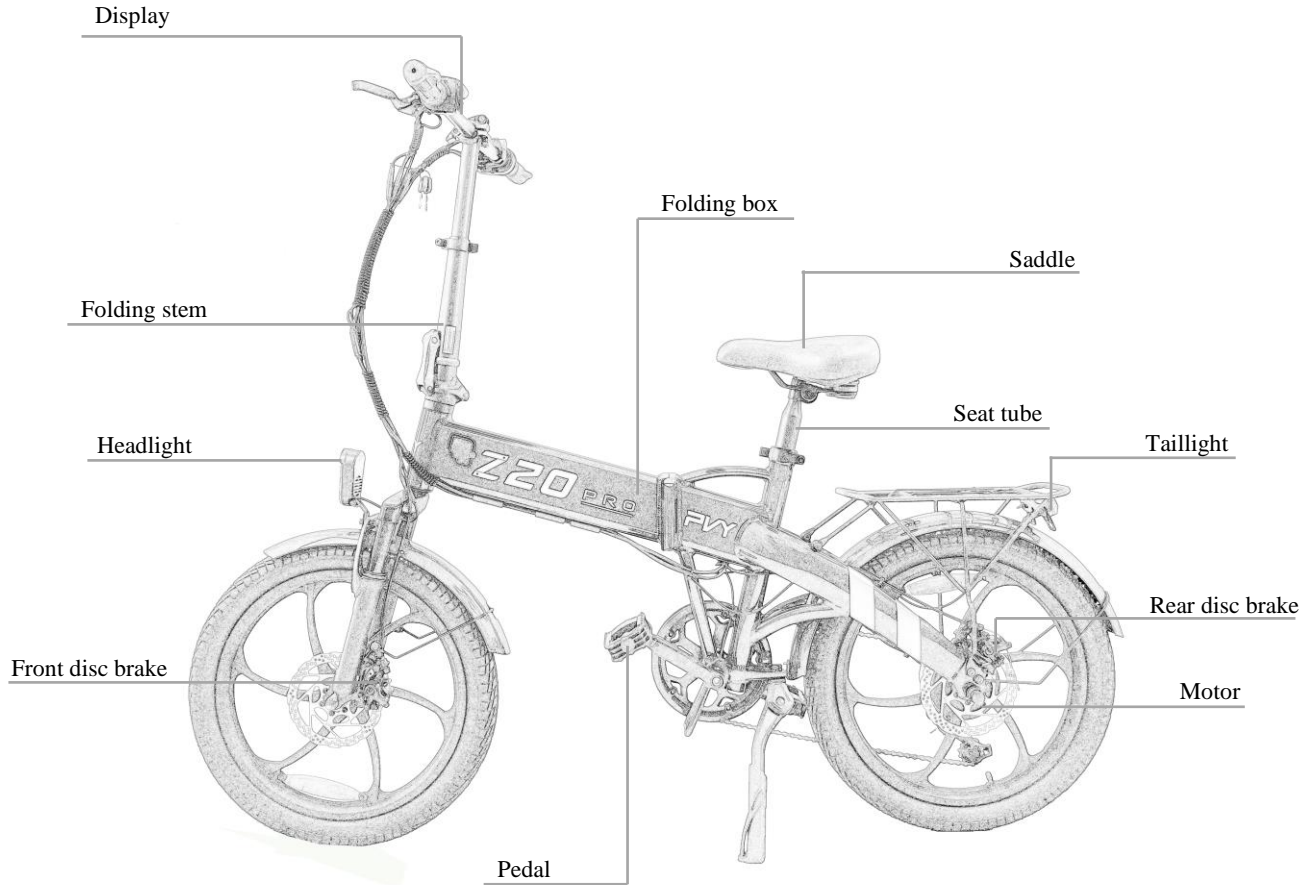

# The battery

## Instructions before use of lithium battery

- Before use, please confirm that the battery model is the original battery, do not use other brands of batteries at will.
- Check the appearance of the lithium battery is in good condition and there is no obvious phenomenon such as damage, liquid leakage, hot water and smoke.
- In order to ensure the safety of transportation, the battery power in the battery plant is about 30%. Due to the power Consumption in the process of transportation and storage, the battery power is low or no during the first use. This is a normal phenomenon, so please do not worry.

## Using the environment

- The best use environment is 10°C-45°C;
- In the case of low temperature, the available capacity of lithium battery will have different degrees of attenuation.The specific reference degree is as follows:  
The available capacity at -10C is about 70%, at 0°C it is 85%,and at 25°C it is 100%.If the battery has odor,heat,deformation another abnormal conditions. please immediately stop using, stay away from the battery and contact the after-sales department.

## Warning

Battery is not a part that can be repaired by users. If there is any abnormal phenomenon, please contact the after-sales department for maintenance.

Unauthorized dismantling of the battery will not be covered by the three-pack policy,and may lead to battery heating,smoking,fire.explosion.

## Charging environment

- Use the battery to support the original factory charger manufacturing line charge, do not use other brand or model charger who line charge.
- Charge the battery at 0°C-40°C to ensure that there are no flammable substances around and good ventilation.
- Charging time description: the charging time of the battery should not exceed 12 hours. Excessive charging will affect the battery life and there are safety risks.
- The battery quantity of the charger rises quickly in the early stage and slowly in the later stage. This is the procedure set for charging safety and is normal.
- Outdoor charging is strictly prohibited in bad weather.
- During the charging process, the surface temperature of the battery box is found to be very high(higher than 55°C), indicating that the battery pack is in trouble. Cut off the power supply immediately and send it to the designated repair station for maintenance. It is normal that the surface of the charger box is slightly heated (no more than 60°C) during the charging process.

## Storage environment

- After the battery is placed in the car, it will slowly consume the battery power due to the vehicle's work. The vehicle can be kept for up to two months. The meter shows that the battery power drops normally.
- When the battery is not used for a long period of time (more than one month), please be sure to remove it from the e-bike and charge the battery to a half-full and full state (after discharging the battery, use the charger for 1.5-2 hours), then store it in a cool and dry room (the best temperature is 5°C-25°C), and charge it for 1 hour every two months.
- Batteries and chargers should be stored in a clean, dry, ventilated place, away from contact with corrosive substances, away from fire and heat sources (must be less than 2 meters), away from flammable substances, and disconnect the charger from the battery.
- The most appropriate storage capacity of the battery is 50%. If the battery is lower than 10% , long-term storage will lead to irreversible capacity attenuation of the battery.
- Avoid placing the battery in a risky location where a drop could cause uncontrollable damage to the battery and cause leakage, heat, smoke, fire or explosion.

# Maintenance and repair

## Maintenance and cleaning instructions

- Do not flush with water to avoid potential accidents caused by wetting of internal electronic parts and wiring;
- Please use neutral cleaner, gently wipe the dirt on the surface of paint or plastic parts with a cloth, and then wipe it clean with a dry cloth.
- Please use lubricating oil to clean the metal parts of the e-bike body for maintenance.
- Do not oil the brake parts to avoid brake failure and danger.

## Regular inspection

- Whether the fastener is locked tight, and whether the joints in each part are normal;
- Whether the tread pattern of the outer tire is worn and cracked, whether the air pressure of the front and rear tires is appropriate, and whether the driving system is smooth;
- Whether the brake system is working normally.

## Vehicle storage method

- When the product is not used for a long time, please do not store it in the outdoor environment, bright light and the environment below zero for a long time. The distance from the heat source (heating equipment, etc.) should not be less than 2M;
- Store in dry, dean, well ventilated indoor environment with temperature between 10°C and 45°C and relative humidity no more than 90%;
- If you do not use the e-bike for a long time, pay attention to charging the battery regularly (generally about two months apart) to maintain battery performance;
- This product should not be in contact with corrosive liquid to avoid any mechanical impact and pressure.

## Trouble shooting

Issue	Reason	Solution way
Turn on the power No power	<ul style="list-style-type: none"> <li>■ No power supply for vehicles</li> </ul>	<ul style="list-style-type: none"> <li>■ Whether the power switch is on or not</li> <li>■ Battery under voltage, charge the battery</li> </ul>
Turn on the power and twist the handle Motor does not start	<ul style="list-style-type: none"> <li>■ In the braking state</li> <li>■ Start switch fault</li> </ul>	<ul style="list-style-type: none"> <li>■ Whether the brake handle is in the braking state</li> <li>■ Contact the after-sales</li> </ul>
Insufficient range	<ul style="list-style-type: none"> <li>■ The battery is undercharged</li> <li>■ Tire pressure is low</li> <li>■ Frequent braking</li> <li>■ Battery aging or normal attenuation</li> <li>■ Low ambient temperature, battery capacity attenuation</li> </ul>	<ul style="list-style-type: none"> <li>■ Check the charger for any damage</li> <li>■ Check the tire pressure before each use</li> <li>■ Develop good driving habits</li> <li>■ Change the battery</li> <li>■ It is normal</li> </ul>
The battery won' t charge witch fault	<ul style="list-style-type: none"> <li>■ The charger is not plugged in properly</li> <li>■ Battery temperature is too low</li> <li>■ Battery temperature is too high</li> <li>■ Battery under voltage</li> </ul>	<ul style="list-style-type: none"> <li>■ Check whether the power plug is loose</li> <li>■ Wait for the battery to resume charging temperature</li> <li>■ Wait for the battery to resume charging temperature</li> <li>■ Contact customer service</li> </ul>

# RoHS

Bike name	Electric help for bicycles					
The name and content of harmful substances in the product						
Parts name	Hazardous substance					
	(Pb)	(Hg)	(Cd)	(Cr(VI))	(PBB)	(PBDE)
Display	○	×	○	○	○	○
Head lamp	○	×	○	○	○	○
Tail lamp	○	×	○	○	○	○
Battery	○	×	○	○	○	○
Controller	○	×	○	○	○	○
Charger	○	×	○	○	○	○

1、 This form is prepared in accordance with the provisions of SJ/T 1136

○:Indicates that the content of the hazardous substance in all homogeneous materials of the part is below the limit set by GB/T 26572.

×:Indicates that the content of the hazardous substance in at least one homogeneous material of the component exceeds the limit specified in GB/T 26572.



**Manufacturers:** Shenzhenshi Paixing Intelligent Technology Co., Ltd.

**Producer:** Shenzhenshi Paixing Intelligent Technology Co., Ltd.

**Manufacturer add:** Shanglin Community, Yuanling Street, Futian District, Shenzhen

**Official Website:** <https://www.pybike.com/>

**Official email:** official@pybike.com